

ADJUSTABLE FAN TIMER

FS-875
FS-3875

Bath Fan Timer Control
with Light Control

ENGLISH
LANGUAGE
MANUAL

from
DewStop[®]

Go To Research
Technologies, Inc.
Seattle, WA, USA

(C.) INSTALLATION STEPS

1. WARNING

To avoid fire or risk of electrical shock, turn OFF power at circuit breaker or disconnect fuse. Test the power is OFF before you begin wiring.

2. BEFORE YOU MOUNT THE CONTROL

(new installation) Install control in a 3½ inch deep single-gang or multi-gang electrical wall enclosure. OR (replacement of existing switch) remove existing wall plate and switch device being replaced.

3. ATTACH POWER WIRE, LIGHT WIRE, AND FAN WIRE

Attach 120V AC 60Hz 3-wire power (Hot / Neutral / Ground) inside the wall enclosure with a minimum of 6 inch leads. Attach fan three wire leads inside the wall enclosure also with minimum 6 inch leads. If an existing power connection is used in an existing wall enclosure you must confirm proper AC 120V Hot / Neutral / Ground are available.

4. CONNECT WIRING

General instructions for all configurations:

Make sure the wall enclosure, fan, light, and control are properly grounded. (See FIGURE #1).

Make sure ground wire is securely fastened. Tighten all ground screws or wire nuts securely. Use the proper sized wire nut for #14 or #12 wire. Make sure to strip back the copper wire 5/8 inch and twist wire and nut clockwise.

(A.) ABOUT

This timer is designed to give you all the options, all the control you need, to make sure your bathroom, laundry room, sun room, or spa room gets all the ventilation it should have. It's really two timers in one: A countdown timer and a fresh home / Minutes Per Hour (MPH) timer – and, best of all, the two timers work together. The countdown timer can be set anywhere from 5 to 60 minutes, and it activates any time you manually turn the fan on. The MPH timer can be set to anywhere from 0 to 60 minutes, and it runs your fan for a set time every hour to expel stale air and help you maintain good indoor air quality (just the thing for complying with local indoor air quality standards, such as ASHRAE 62.2). The MPH timer also sees when you've used the countdown timer and knows not to run the fan for a while if you've already done it. If you want to manually shut the fan off when the MPH timer is running, you can do that too, just by pressing the fan on/off button.

(B.) INSTALLATION INSTRUCTIONS

CAUTION

1. Use only a 120V AC 60Hz power supply connection.
2. For indoor use only.
3. Do not exceed this control's maximum electrical load ratings, as indicated on the product label.
4. Must be installed and used in accordance with your local electrical codes.
5. If a bare copper or green ground connection is not available in the wall box, contact a licensed electrician for installation.
6. For use with permanently installed 120V AC powered fans only.
7. Use only #14 or #12 copper wire connections.

(D.) MOUNTING IN WALL ENCLOSURE

1. Attach wires (as shown in FIGURE #1).

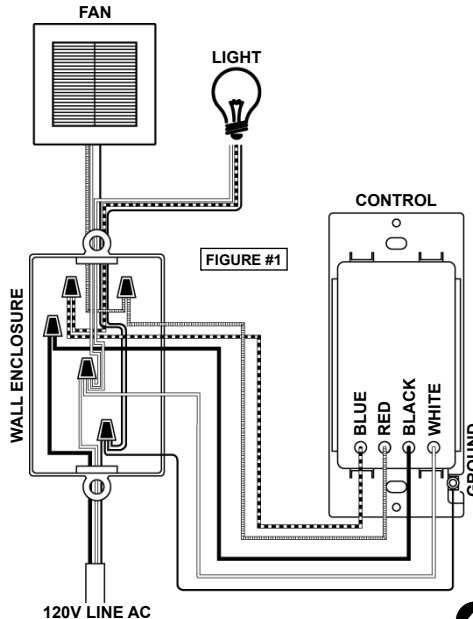

WARNING

Turn OFF circuit breaker or remove fuse(s) and test that power is OFF before wiring. Wiring this control live can cause serious risk of electrical shock and/or damage the control, voiding the warranty. FOR SAFETY, THIS PRODUCT MUST BE INSTALLED IN A GROUNDED WALL ENCLOSURE. If you are unfamiliar with methods of installing electrical wiring, secure the services of a qualified licensed electrician. USE ONLY COPPER WIRE, DO NOT use aluminum wire with this device.

IMPORTANT

Read each step carefully and perform in sequence. This control will not work or will become damaged if wires are connected incorrectly. To prevent damage, connect this control exactly as shown in the installation diagrams, otherwise warranty will be voided. Prior to wiring, straighten or clip ends of wire such that ends of each wire are straight (if using this control to replace an existing switch). Strip wire insulation at the end of each wire to expose 5/8 inch (16 mm) of copper. Where instructed to make a connection, twist ends of stripped wires together and twist a proper connector clockwise until secure.

2. Tuck wires into wall enclosure and fasten control to the wall enclosure with the two screws provided (See FIGURE #2).

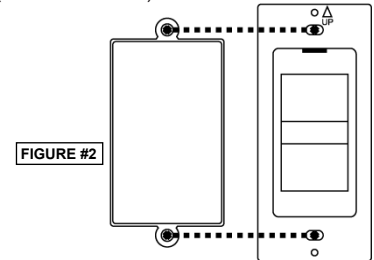

3. Attach the wall plate (See FIGURE #3).

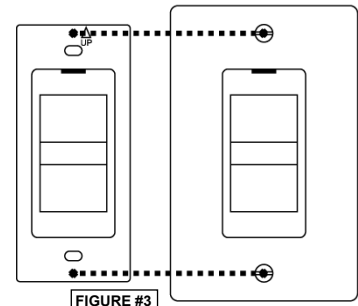

(E.) CONTROL FUNCTIONS

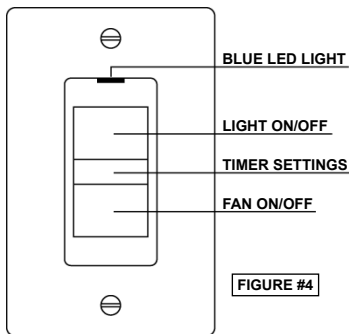
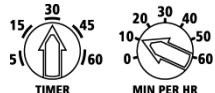

FIGURE #4

Blue LED Light: Lets you know when your fan is on (especially useful for fans with low sound levels).

Light ON/OFF: Turns light ON and OFF.

Timer Settings: Countdown timer (left) and minutes per hour (MPH) timer (right) settings (hidden behind a removable cover – see page 7 for details).



Fan ON/OFF: Turns countdown timer ON and OFF (can be used to temporarily override the MPH timer – see page 9 for details).

6

(F.) CHANGING THE TIMER SETTINGS

By default, this control comes with the countdown timer set to 30 minutes, and the MPH timer set to 0 minutes. To change the settings, remove the "Timer Settings" cover by taking off the face plate and then inserting the end of the included tool (or a **non-metal** tool of your own) into the two holes on either side of the control (see FIGURE #5). Use the included tool to turn the settings dials. The countdown timer can be set between 5–60 minutes. The MPH timer can be set between 0–60 minutes. Once you change a setting, the changes will take effect after the next ON/OFF cycle, so it's recommended that you turn your fan ON then OFF after you make a change to the settings.

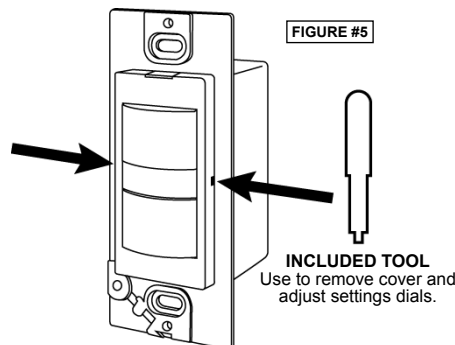
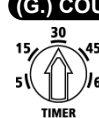

FIGURE #5

INCLUDED TOOL
Use to remove cover and adjust settings dials.

7

(G.) COUNTDOWN TIMER



Pressing "Fan ON/OFF" switches the fan (and the blue LED light) ON and OFF. When the fan is turned ON manually, the countdown timer will run your fan for your selected period of time, then shut your fan OFF for you. For optimal use, we recommend adding together the time it takes you to shower with the time it takes your bathroom to dry off after you shower, then using that total as your setting for this timer.

(H.) MINUTES PER HOUR (MPH) TIMER



This timer runs your fan for a selected amount of time every hour, to help ensure good indoor air quality (it's also designed to help you more easily comply with indoor air quality standards). For example, set to "0", the MPH timer will never turn on. Set to "10", the MPH timer will turn your fan on 10 minutes every hour. Set to "60", the MPH timer will run your fan all the time.

8

(I.) HOW BOTH TIMERS WORK TOGETHER

Credits: The MPH timer is also programmed to give you "credits" for manual use. For example, if you manually run the fan for 10 minutes, and the MPH timer is set to 20 MPH, then the MPH timer will only run your fan for 10 minutes over the next hour, because you've already taken care of the rest. And this works within a rolling 3 hour window of time. For example, if the MPH timer is set to run your fan for 10 minutes per hour, and you run your fan manually for 40 minutes, the MPH timer will take 30 of the 40 minutes (discarding the extra 10 minutes) and recognize that it doesn't need to run the fan for the next three hours. And, if you run your fan for 40 minutes again sometime within the next 3 hours, the MPH timer will roll that forward and again run your fan for the next 3 hours, starting from this latest manual use.

Manual ON: If the MPH timer has your fan ON when you want to use the countdown timer for a shower or bath, pressing the "Fan ON/OFF" button twice will cancel the MPH timer and start the countdown timer in it's place.

Manual OFF: If the MPH timer has your fan ON, and you manually turn it OFF, that cancels out the MPH timer for the hour (the MPH timer will resume normal function after one hour).

9

(J.) TESTING THE CONTROL

1. After you have completely installed this control, selected your timer settings, and attached the wall plate on the control, you can turn on the breaker to apply power.

WARNING: If the breaker trips or the fuse blows, STOP and call a qualified electrician to investigate the problem. Turn the breaker OFF until the problem has been corrected.

2. Press the Fan ON/OFF button to see the fan turn ON, press the button again to see the fan turn OFF. Do the same for the Light ON/OFF button.

ELECTRICAL SHOCK WARNING:

This control is an automatic ON device. At no time should a person work on the fan/light or any appliance connected to this control without the electrical circuit breaker or fuse switched OFF. One of the control's timers could turn ON the attached device while the work is being performed. Always disconnect the AC power before any work is done to any part of the circuit this control is connected to. If you do not understand this warning seek the services of a qualified licensed electrician.

(L.) TWO-YEAR LIMITED WARRANTY

Go To Research Technologies, Inc. (GTR) warrants to the original consumer purchaser of its products that such products will be free from defects in materials & workmanship for a period of two years from the date of original purchase. There are no other warranties, express or implied, including but not limited to, implied warranties of merchantability or fitness for a particular purpose. During this two-year period, GTR will, at its option, repair or replace, without charge, any product or part which is found to be defective under normal use & service. This warranty does not extend to fluorescent lamp starters & tubes. This warranty does not cover (a) normal maintenance & service or (b) any maintenance or repair, faulty installation or installation contrary to recommended installation instructions. The duration of any implied warranty is limited to the two-year period as specified for the express warranty. Some areas do not allow limitation on how long an implied warranty lasts, so the above limitation may not apply to you. GTR's obligation to repair or replace, at GTR's option, shall be the purchaser's sole & exclusive remedy under this warranty. GTR shall not be liable for incidental, consequential, or special damages arising out of or in connection with product use or performance. Some areas do not allow the exclusion or limitation of incidental or consequential damages, so the above limitation may not apply to you. This warranty gives you specific legal rights, & you may also have other rights, which vary from area to area. This warranty supersedes all prior warranties. To qualify for warranty service, you must (a) notify GTR at the address stated below or via our website at www.DewStop.com, (b) give the model number & part number identification, & (c) describe the nature or any defect in the product or part. At the time of requesting warranty service, you must present evidence of the original purchase date.

Go To Research Technologies, Inc.
www.DewStop.com

10

11